

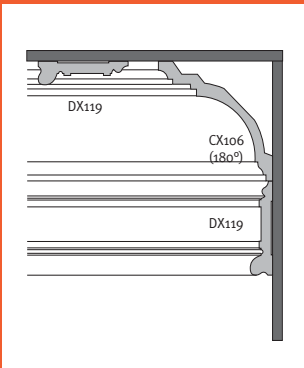

THE ORAC USER MANUAL



T H E O R I G I N A L

ORAC

CORPORATION

ADHESIVES
2

MITRES
4

FB10
4

mitre boxes
5

mitres
5

stop mitre
6

rigid
mouldings
8

flexible
mouldings
11

mouldings
indirect
lighting
12

INSTALLATION
8

indirect
lighting
14

Xinnix®
16

LED
18

THE ORAC USER MANUAL

1. ADHESIVES 2

DECOFIX Pro
DECOFIX 2in1
DECOFIX Hydro
DECOFIX Extra

2. MITRES 4

2.1 setting up FB10 4
2.2 various mitre boxes 5
2.3 mitring corners 5
2.4 stop mitre 6
2.5 examples & ideas 7

3. INSTALLATION 8

3.1 installation of rigid cornice mouldings 8
3.2 installation of flexible cornice mouldings 11
3.3 installation of cornices for indirect lighting 12
3.4 installation of light plates 14
3.5 installation of Xinnix® 16
3.6 installation of LEDS 18
3.7 usage of various lamps 20

4. EXAMPLES & IDEAS 21

1. ADHESIVES

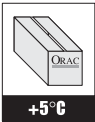
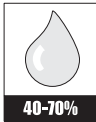

	normal adhesive	normal filler
initial tack	++	--
adhesive after 28 days	++	--
ease of finish with sand paper	+	+++
ease of wash with water	++	++
NO shrinkage	--	+++
ease of installation	++	++

overview ORAC DecoFix products



DecoFix Pro

FDP500 310ml 7 à 8m
FDP600 2700ml ± 48m

DECOFIX PRO
Extra strong
installation adhesive

A slow-drying EXTRA STRONG glue that ensures a long lasting seal between the mouldings and the wall and/or the mouldings and the ceiling (for both Decor and Axxent ranges). It can be painted after hardening (24 hrs).



DecoFix 2in1

FDP800 310ml 7 à 8m

DECOFIX 2in1
Installation adhesive and
joint filling product

A slow-drying glue that ensures a long lasting seal between the mouldings and the wall and/or the mouldings and the ceiling (for both Decor and Axxent ranges). The adhesive can also be used as a filling product and can be removed with water. It can be painted after hardening (24 hrs).



DecoFix Hydro

FDP700 290ml 7 à 8m

DECOFIX HYDRO
Installation adhesive and
joint filling product
for exterior applications

Use DecoFix Hydro for exterior applications and in damp environments instead of DecoFix 2in1.



DecoFix Extra

FX200 310ml ± 150m
FX210 80ml ± 40m

DECOFIX EXTRA
Joint adhesive

A glue for seam joints between the mouldings (for both Decor and Axxent ranges). Any excess of DecoFix Extra can be removed preferably before hardening (with acetone). It can be sanded after hardening (at least two hours). The adhesive can be painted after 24 hrs.

+++	++	++++	+++ only joints
++++	++	++++	++++ only joints
++	++++	+	+
++	++++	- only with soap solution or acetone	-- only with acetone
++	++++	++++	+++
+++	++++	++	++

2. MITRES



2.1 setting up FB10

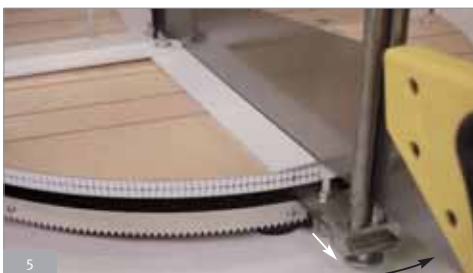

2.2 ORAC mitre boxes



FB13



FB300



FB10



FB14

2.3 mitring corners

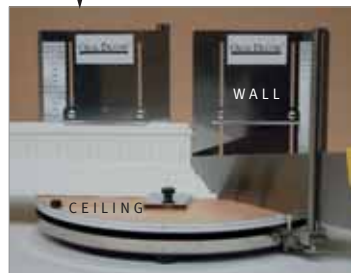

2.4 stop mitre

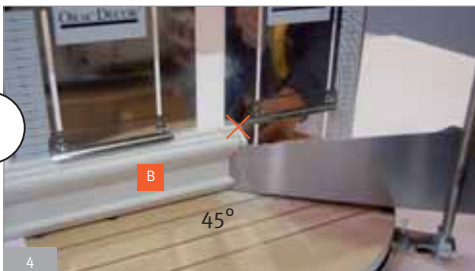
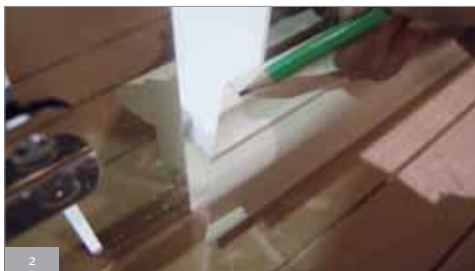

2.5 examples & ideas

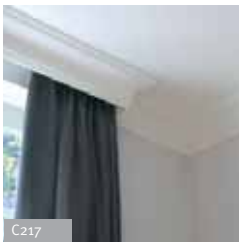

3. INSTALLATION

3.1 installation of hard cornice mouldings

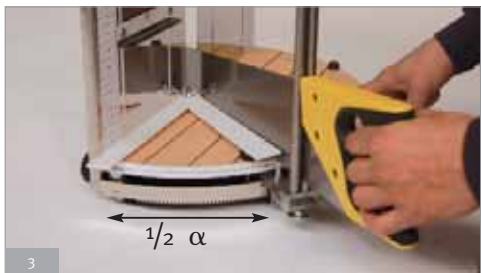
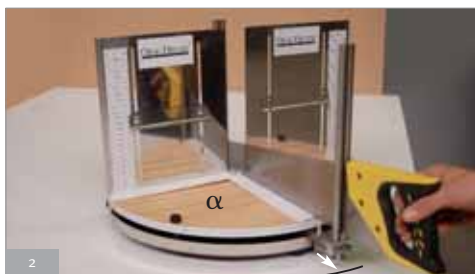
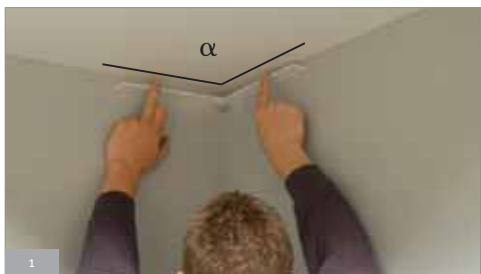

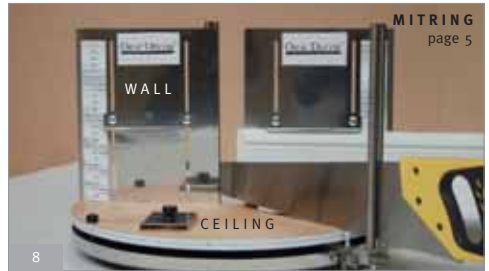

* for exterior applications and in damp environments.

>> 3.1 installation of hard cornice mouldings

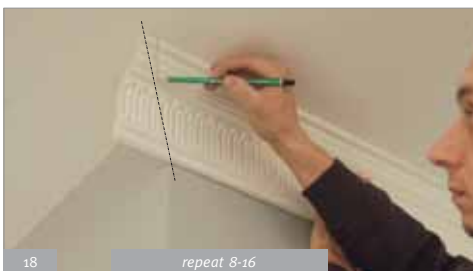

* for exterior applications and in damp environments.

3.2 installation of flexible mouldings

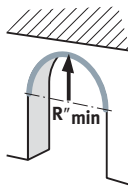
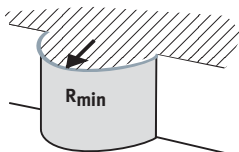
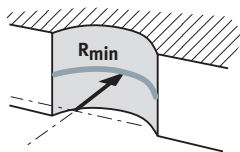

Ref **R_{min}**
(meter)

C200F	1,5
C201F	1,4
C211F	3,2
C212F	1,4
C213F	2,3
C214F	1,1
C215F	1,7
C216F	3,4
C217F	3,4
C218F	3,7
C219F	2,9
C220F	2,9
C230F	1,1
C240F	2,3
C250F	1,1
C260F	1,5
C300F	3,4
C301F	3,0
C302F	2,1
C303F	1,8
C304F	1,7
C305F	2,9

Ref **R_{min}**
(meter)

C307F	4,6
C308F	1,4
C321F	1,4
C322F	1,2
C331F	4,6
C332F	4,9
C333F	3,7
C334F	4,1
C353F	2,9
C354F	2,9
C355F	2,9
C356F	2,9
C360F	2,9
C400F	3,2
C401F	1,8
C402F	1,8
C422F	3,7
C602F	1,4
C900F	4,0
C901F	3,7
C902F	4,0

Ref **R_{min}** **R' min**
(meter) (meter)

P1020F	0,3	08
P2020F	0,3	0,8
P3020F	0,9	1,8
P4020F	0,9	0,9
P5010F	0,5	2,7
P5020F	0,5	2,7
P5021F	0,3	0,8
P5050F	0,5	4,6
P5051F	0,5	4,6
P6020F	0,5	1,5
P7010F	0,3	3,0
P7020F	0,3	2,9
P7030F	0,3	1,5
P7040F	0,5	1,8
P7050F	0,5	1,5

Ref **R_{min}** **R' min**
(meter) (meter)

P7060F	1,5	1,8
P7070F	0,5	2,7
P7080F	0,5	/
P8020F	0,5	1,4
P8030F	0,3	0,6
P8040F	0,3	2,9
P8050F	0,3	2,7
P8060F	0,3	3,0
P9010F	0,5	2,6
P9020F	0,5	2,7
P9040F	0,5	0,9
P9050F	0,3	0,8
SX105F	0,5	/
SX118F	0,5	/

ORACAXXENT®



3.3 installation of cornices for indirect lighting



Similar installation instructions for:
- C900, C901, C902 (ORAC Decor)
- C351, C352, C357, C358 (ORAC Myline)

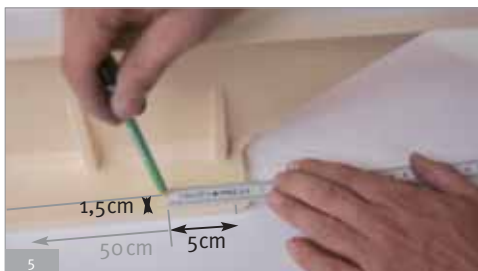
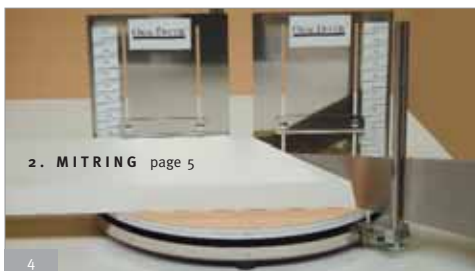
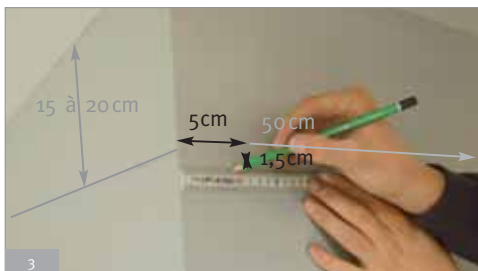
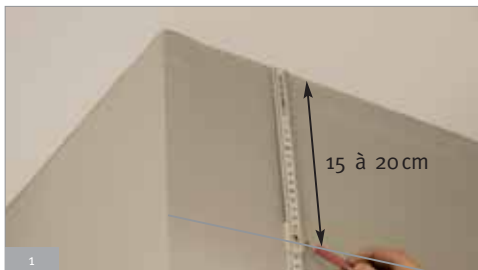



3.4 installation of light plates



IL001-004
light plate 2230mm
dimmable - T5 2x28W

IL001-002
light plate 550mm
dimmable - T5 1x14W

lamps: see page 20

Lightplates to use with C900, C901, C902, C351, C352, C357, C358. Check detailed installation instructions in packaging, for more information about number of lightplates, connection to the main electricity supply and wiring chart.

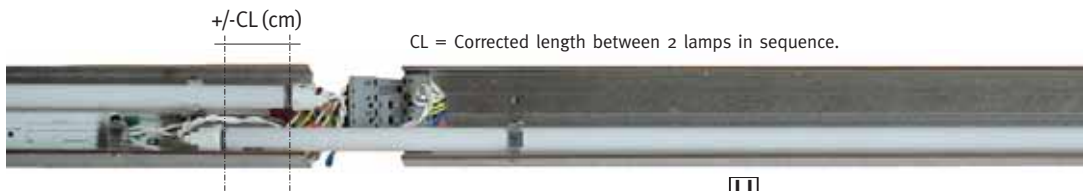

5



- * ILo00-001 5 x plexi cover for C357, 100 cm
- IL000-002 5 x plexi cover for C358, 100 cm

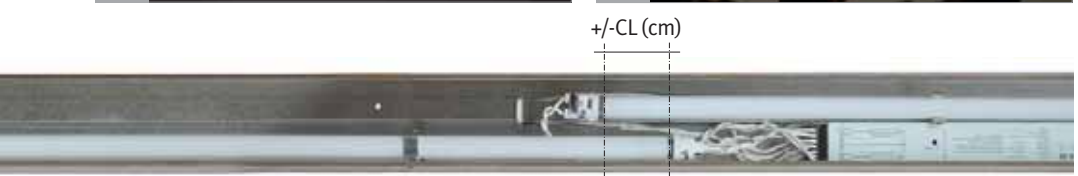
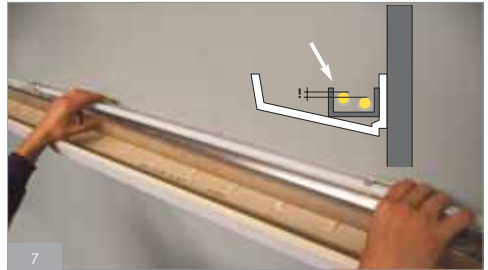
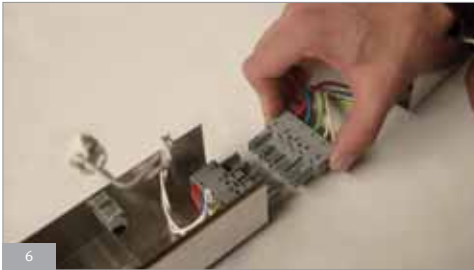

+/-CL (cm)

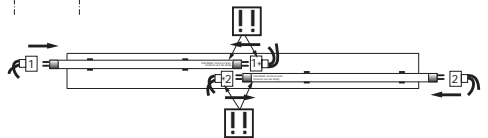
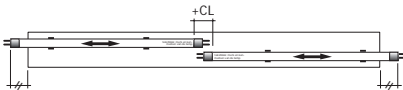

3.5 installation of ORAC Xinnix®

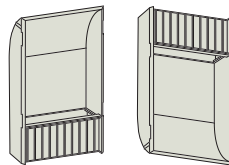

L600-001
for compact fluorescent 18W - **Up & down light**

L600-002
for halogen lamp 60W or 100W - **Uplight only**

lamps: see page 20

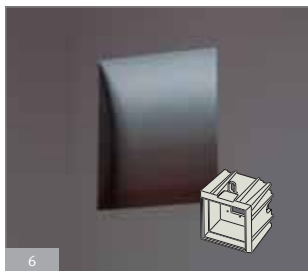

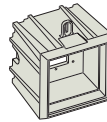

lamps: see page 20



3.6 installation of LEDs



- ILo03-001**
 (A) set of 5 LED inserts, 1W
 Ø4 cm, thickness 9 mm
 (B) 5 cables 1m.
 (C) 1 power converter max. 5 units

ILo03-002
 power converter max. 40 units

ILo03-003
 extension cables 1x(1m + 2m + 3m)

ILo03-004
 set of 5 multi-connectors

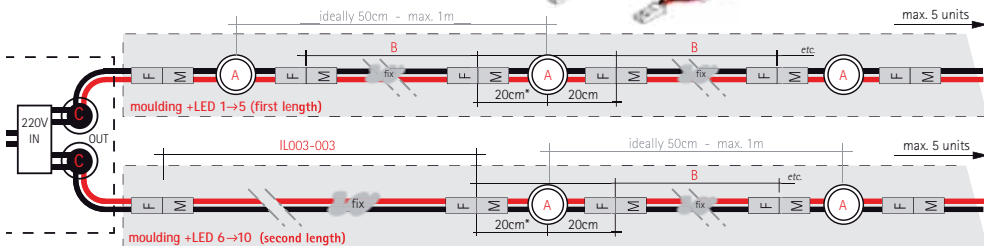



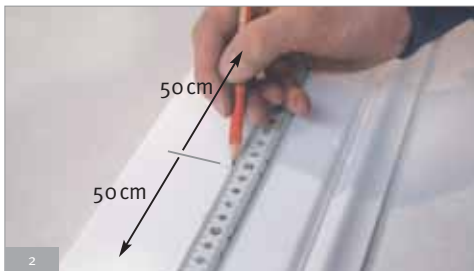
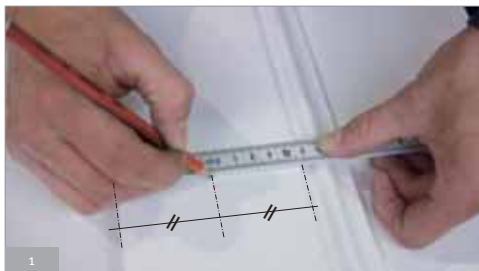







* Possibility to replace a LED lamp.



Use ILo03 for example in C220, C305, C400, C354, P5050, P5051, SX104, SX105, SX118, SX137, SX138, TF06, ...



3.7 usage of various lamps

lamp type*		lamp cap	remark	ORAC application
T5 HE 14W		G5	several white colors + RGB	IL001-002
T5 HE 28W		G5	several white colors + RGB	IL001-004
Compact Fluorescent 18W		G24-q2	several white colors	L600-001 up/downlight
T11 halogen 60W		R7s		L600-002 uplight only
T11 halogen 100W		R7s		L600-002 uplight only
Mycro-Lynx F 7W		GX53	3 white colors	L601-001
Mycro-Lynx F 7W red		GX53		L601-001
Mycro-Lynx F 7W blue		GX53		L601-001
Mycro-Lynx F 7W green		GX53		L601-001
Mycro-Lynx LED white clear		GX53	5 colors	L601-001
set of 5 LED inserts 1W + convertor				various mouldings (see page 18)

* lamps not
supplied by ORAC

4. EXAMPLES & IDEAS



C355



K201/200, B403, D120, C308



C353



L600



C333



P801C, P8020



P3020, R12, C214



CX100, PX103



2 x P4020 + GB03



PX113 + SX122



P8020



C351



P4020 + C901 + P7020



C322, SX118, PX147



C305 + P8020

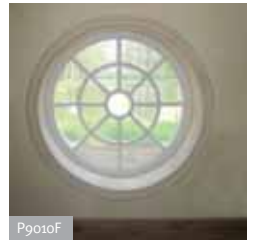

P9010F

This catalogue and the designs embodied within are protected by copyright law and international treaties. Unauthorized reproduction of the catalogue or any portion of it or reproduction of any of the designs embodied therein may result in severe civil and criminal penalties and will be prosecuted to the maximum. All rights reserved. ©2007, ORAC - layout: FABworks.be

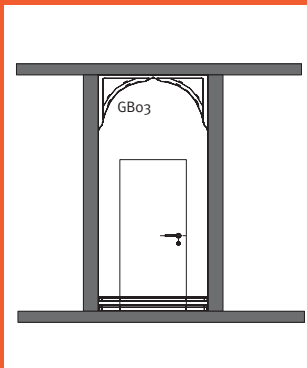

MP011 - 0207

nv ORAC sa
Oudenburgsesteenweg 90, B-8400 Oostende
Tel: +32 (0)59-80 32 52 - Fax: +32 (0)59-80 28 10
sales@oracdecor.com - www.oracdecor.com